

AUTOBOT

TIGERTRACK

Revision 1.1

STRENGTH	INTELLIGENCE	SPEED	ENDURANCE	RANK	COURAGE	FIREPOWER	SKILL
8	6	9	7	3	10	7	10

Motto: Tracking the lingering scent of enemies is all too easy.

Function: Sentry

Class: Spychanger

Profile: A cool, relentless hunter. Enjoys hunting down those enemies that have eluded capture or have ventured too far from their own base. Has among the best sensors of the Spychangers, can detect even the faintest traces of enemy exhaust in the most adverse conditions. Decidedly not a team player, often unreliable in regular combat situations, since he would rather be hunting his prey one-on-one.

Weapons: Electron pulse gun.

INSTRUCTIONS

TIGERTRACK

Setting Up: Print out the parts page and be sure to let the ink completely dry. Get out some white glue and a decent pair of scissors.

Hinge Joint: Start by cutting out the three hinge pieces. Fold each into a box and glue them into shape. Then, glue one long side of the center piece (marked '2') onto the center of one side the large hinge prism (marked '1'). Glue the shorter hinge prism (marked '3') in the same way on the opposite side. Let hinge assembly dry.

Hood Assembly: Cut out the pieces marked 'hood' and 'chest'. Fold and glue each piece into boxes with the exception of the open flaps. Let dry.

Insert the longer part of the hinge joint into the hood via the flap. Insert the smaller part of the hinge joint into the chest the same way. Glue down the flaps to secure the joint in place, being sure that no glue gets in the hinge itself. Let dry.

Cut out the two 'front tires' pieces, folding them and gluing them into shape so that the 'inside' of each tire is roughly half-height, and the outside

is a 'full' tire side. Glue the tires onto the outside lower corner of the hood where indicated. Allow to dry.

Cut old and fold grill covers in half, gluing into 'heavy slips'. Glue covers to front of the hood, where indicated.

When complete, the hood should swing freely around the chest via the hinge joint.

Arm Assembly: Cut out one piece marked 'shoulder', one piece marked 'arm' and one piece marked 'arm lock'. Cut and fold each into boxes and let dry. Glue the shoulder onto one end of the arm lock. On the opposite side of the shoulder, glue the arm into place. When done, the arm assembly should resemble a 'j' shape.

Repeat the steps above for the opposite arm assembly. Let them both dry completely.

Cut out the back piece and glue together, leaving the flap open. Let dry. Hook in each arm to within the side flaps and secure back piece down with glue. When complete, the arm as-

sembly should slide freely into and out of the back piece.

Body Assembly: Cut out the 'torso' piece, then fold it and glue it into a box shape. Line up the back and torso pieces evenly, gluing them together. Glue the 'chest' piece to the front of the torso assembly, making sure that the arm hooks are on top, and in the center on each side. Allow entire assembly to dry.

Cut out head piece, folding and gluing it into a box as normal. Glue to top of torso and let dry. When done, the hood should be able to feely swing over the head, covering it up.

Cut out the waist and cod piece parts, making boxes yet again. Glue waist to bottom of the torso, and then the cod piece to the front of the waist. Let body assembly dry.

Leg Assembly: Cut out leg pieces. Fold each into a box, glue into shape, and then let dry. Glue one end of each leg onto the marked gray areas at the bottom of the waist piece.

Cut out leg brace piece. Fold into a box with the sides open and glue into shape. Glue brace onto the undersides of the legs and let dry.

Cut out lower legs piece, fold into a box and glue sides and bottom. Insert legs and leg brace into the top of the lower legs piece. Secure the lower legs into place by gluing down the flaps and then letting dry. The upper legs should slide snugly but freely within the lower legs.

Cut out cod piece. Fold into a box and let dry. Glue into the front of the waist piece so that the graphic detail faces forward.

Vehicle Assembly: Cut out the two door panel pieces. Fold in half and glue down into panels. Glue panels to the outsides of the arms so that the graphic detail is facing outside, and that it is

properly lined up with the vehicle mode.

Cut out rear canopy pieces. Fold and glue read canopy into a boxes and glue to the back of either side of the lower legs piece, so that it lines up with the main canopy when figure is in robot mode. Let dry.

Cut out spoiler and fold in half, gluing it into a think 'blade'. Cut out spoiler base and fold and glue into a box. Glue spoiler onto base, lining up the center lines of each. Glue spoiler to the very bottom of the back of the robot lower legs. Allow to dry. Use the spoiler and feet placement to balance the robot mode's standing.

Cut out all tire pieces and fold into shape. Glue back half of tires to front half, using tab to create an 'L' shape with which to glue completed tires to the vehicle frame. Let assembly dry.

Transformation: To Transform into robot mode, extend lower legs from body. Extend arms from sides. Swing hood down to form robot chest. To return to vehicle mode, reverse the order of these instructions.

Paperformers (c)2003-2010 Neale Davidson

This is not a product officially created or maintained by Hasbro, Inc. Transformers™ and all related works are trademarks of Hasbro, Inc, Pawtucket, RI 02862, USA. All Rights Reserved. This guide is not intended to infringe upon these property rights of Hasbro, Inc, and has been established for entertainment purposes only.

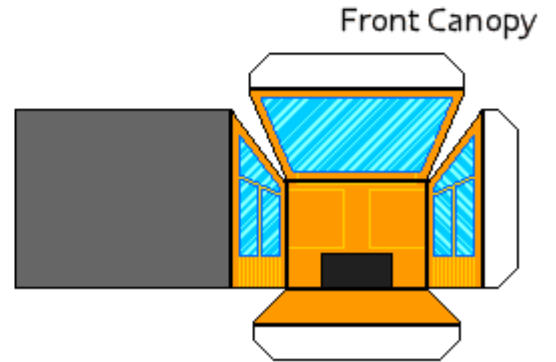
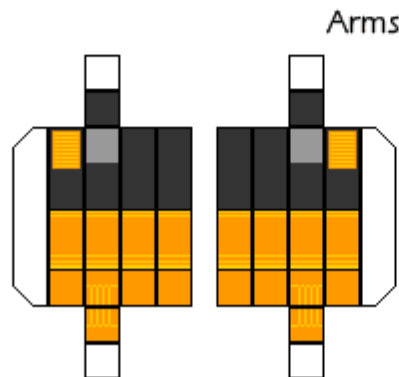
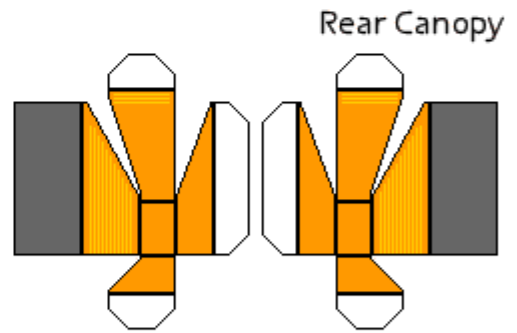
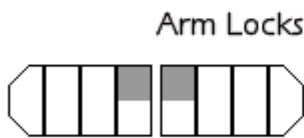
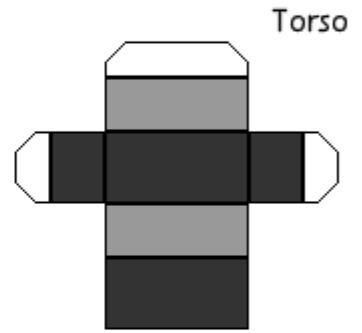
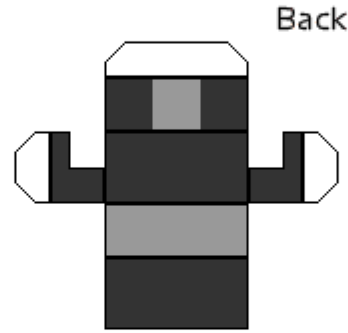
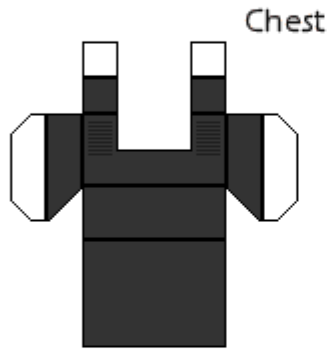
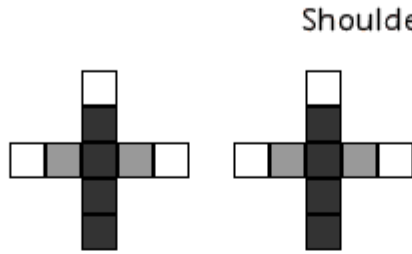
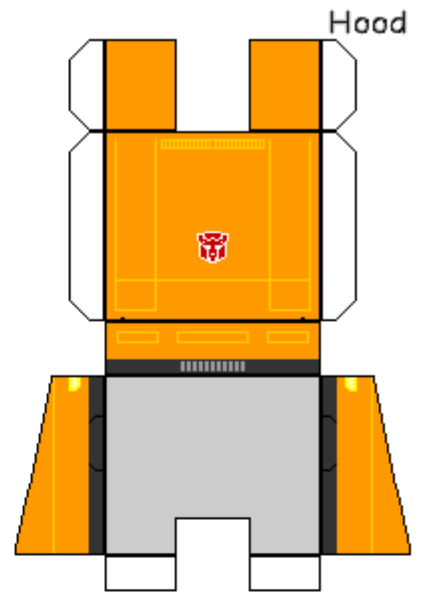
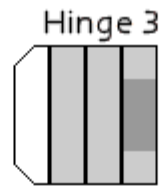
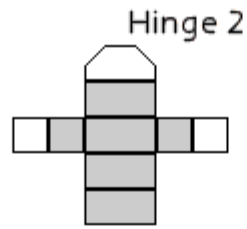
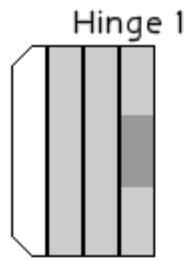

Leg Brace



Cod Piece

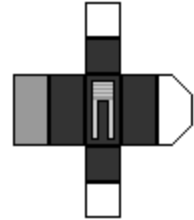

Waist

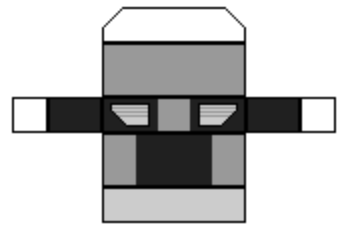

Upper Legs

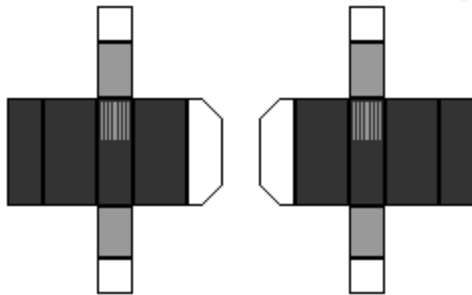

Feet

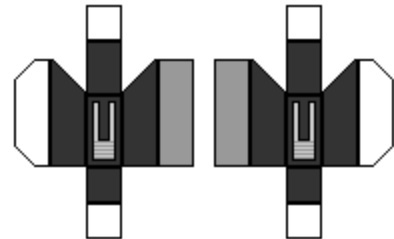

Spoiler



Spoiler Base

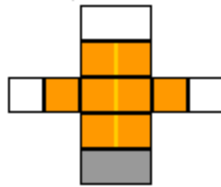

Lower Legs

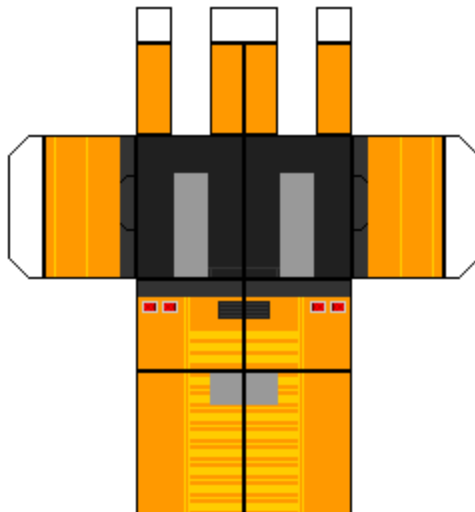

Door Panels



Tires

